

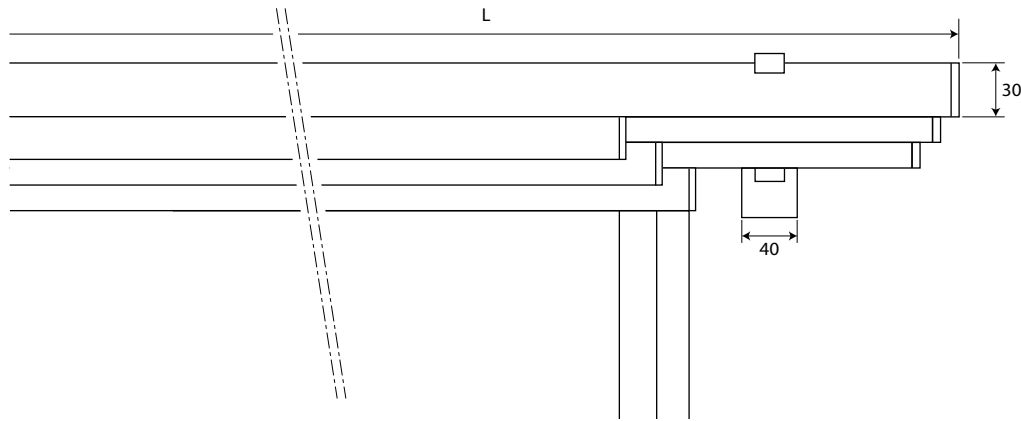



ERMINIA



Cod. 353C45

Sistema a parete - 3 vie
Wall system - 3 ways
Système de face - 3 voies
Wandmontage - 3läufig
Sistema pared - 3 vías
System ścienny - 3 biegi

Cod. 353E45

Sistema a parete - 4 vie
Wall system - 4 ways
Système de face - 4 voies
Wandmontage - 4läufig
Sistema pared - 4 vías
System ścienny - 4 biegi

Cod. 353F45

Sistema a parete - 5 vie
Wall system - 5 ways
Système de face - 5 voies
Wandmontage - 5läufig
Sistema pared - 5 vías
System ścienny - 5 biegi

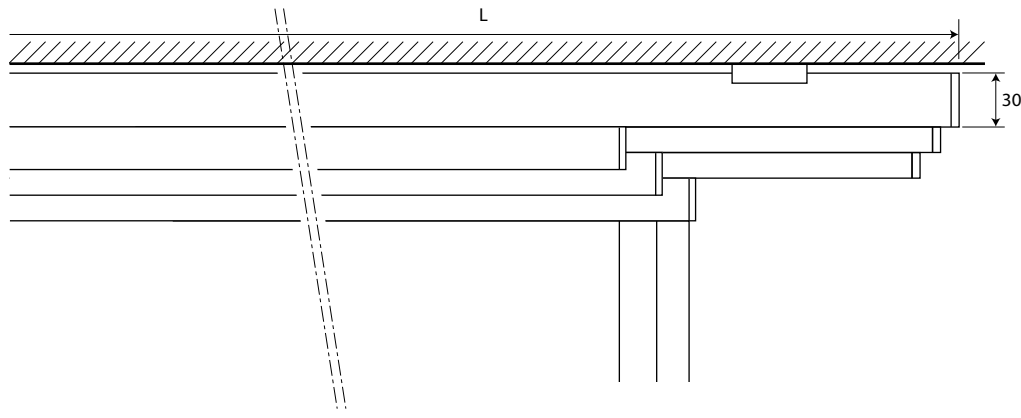
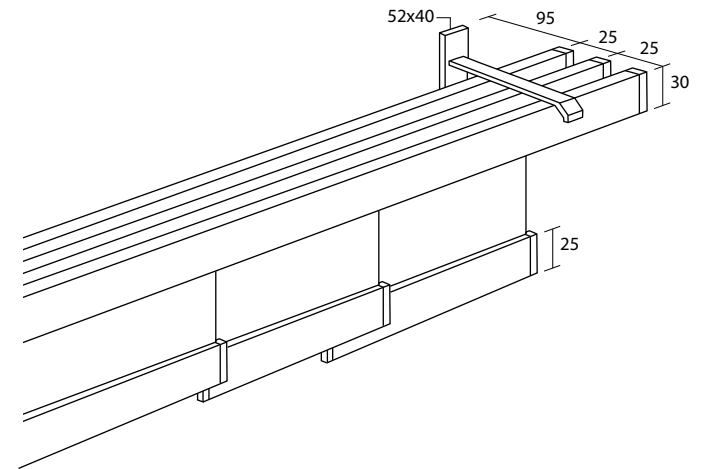

Cod. 353H45

Sistema a soffitto - 3 vie
Ceiling system - 3 ways
Système plafond - 3 voies
Deckenmontage - 3läufig
Sistema techo - 3 vías
System sufitowy - 3 biegi

Cod. 353L45

Sistema a soffitto - 4 vie
Ceiling system - 4 ways
Système plafond - 4 voies
Deckenmontage - 4läufig
Sistema techo - 4 vías
System sufitowy - 4 biegi

Cod. 353M45

Sistema a soffitto - 5 vie
Ceiling system - 5 ways
Système plafond - 5 voies
Deckenmontage - 5läufig
Sistema techo - 5 vías
System sufitowy - 5 biegi

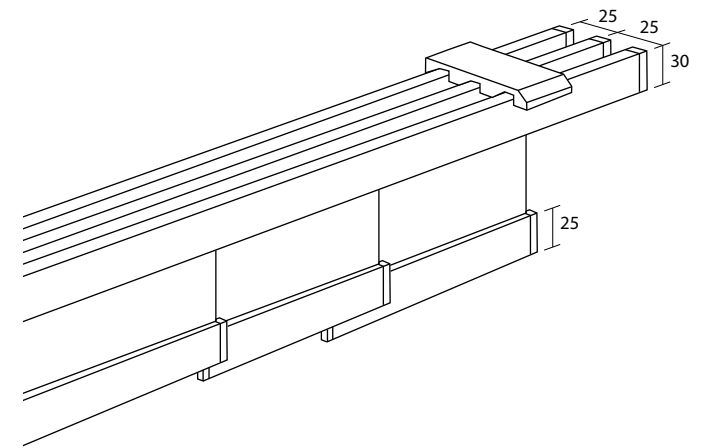

25



67



312

FIN 25 - 312

3 vie - 3 ways - 3 voies - 3läufig - 3 vías - 3 biegi

L - cm CT	140						160						180						200					
	A	B	C	D	E	F	A	B	C	D	E	F	A	B	C	D	E	F	A	B	C	D	E	F
160	C - cm																							
180																								
200																								
220																								
240																								
260																								
280																								
300																								
320																								

L - cm CT	220						250						300						340					
	A	B	C	D	E	F	A	B	C	D	E	F	A	B	C	D	E	F	A	B	C	D	E	F
160	C - cm																							
180																								
200																								
220																								
240																								
260																								
280																								
300																								
320																								

Maggiorazioni - Surcharges - Suppléments - Zuschläge - Suplementos - Dodatkowa opłata

L - cm	140	160	180	200	220	250	300	340
67								

FIN = Finitura - Finish - Finition - Fertigung - Acabado - Wykończenie

L = Larghezza sistema (cm) - System width (cm) - Largeur système (cm) - Gesamtbreite (cm) - Ancho sistema (cm) - Szerokość systemu (cm)

CT = Classe tessuto - Fabric category - Catégorie tissu - Gewebegruppe - Categoría tejido - Klasa tkaniny

C = Altezza tessuto (cm) - Fabric height (cm) - Hauteur de la toile (cm) - Stoff Höhe (cm) - Altura tejido (cm) - Wysokość tkaniny (cm)

FIN 25 - 312

4 vie - 4 ways - 4 voies - 4läufig - 4 vías - 4 biegi

L - cm CT	180						200						220					
	A	B	C	D	E	F	A	B	C	D	E	F	A	B	C	D	E	F
160																		
180																		
200																		
220																		
240																		
260																		
280																		
300																		
320																		

L - cm CT	250						300						340					
	A	B	C	D	E	F	A	B	C	D	E	F	A	B	C	D	E	F
160																		
180																		
200																		
220																		
240																		
260																		
280																		
300																		
320																		

Maggiorazioni - Surcharges - Suppléments - Zuschläge - Suplementos - Dodatkowa opłata

L - cm	180	200	220	250	300	340
67						

FIN = Finitura - Finish - Finition - Fertigung - Acabado - Wykończenie

L = Larghezza sistema (cm) - System width (cm) - Largeur système (cm) - Gesamtbreite (cm) - Ancho sistema (cm) - Szerokość systemu (cm)

CT = Classe tessuto - Fabric category - Catégorie tissu - Gewebegruppe - Categoría tejido - Klasa tkaniny

C = Altezza tessuto (cm) - Fabric height (cm) - Hauteur de la toile (cm) - Stoff Höhe (cm) - Altura tejido (cm) - Wysokość tkaniny (cm)

FIN 25 - 312

5 vie - 5 ways - 5 voies - 5läufig - 5 vías - 5 biegi

L - cm CT	220						250					
	A	B	C	D	E	F	A	B	C	D	E	F
160												
180												
200												
220												
240												
260												
280												
300												
320												

L - cm CT	300						340					
	A	B	C	D	E	F	A	B	C	D	E	F
160												
180												
200												
220												
240												
260												
280												
300												
320												

Maggiorazioni - Surcharges - Suppléments - Zuschläge - Suplementos - Dodatkowa opłata

L - cm	220	250	300	340
67				

FIN = Finitura - Finish - Finition - Fertigung - Acabado - Wykończenie

L = Larghezza sistema (cm) - System width (cm) - Largeur système (cm) - Gesamtbreite (cm) - Ancho sistema (cm) - Szerokość systemu (cm)

CT = Classe tessuto - Fabric category - Catégorie tissu - Gewebegruppe - Categoría tejido - Klasa tkaniny

C = Altezza tessuto (cm) - Fabric height (cm) - Hauteur de la toile (cm) - Stoff Höhe (cm) - Altura tejido (cm) - Wysokość tkaniny (cm)

ERMINIA

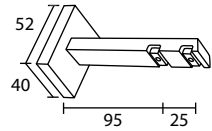

353229

Supporto parete 2 vie
2 ways wall bracket
Support de face 2 voies
2läufiger Wandträger
Soporte a pared 2 vías
Wspornik do ściany 2 biegi

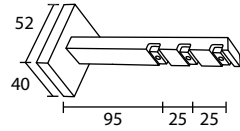

353239

Supporto parete 3 vie
3 ways wall bracket
Support de face 3 voies
3läufiger Wandträger
Soporte a pared 3 vías
Wspornik do ściany 3 biegi

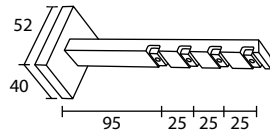

353249

Supporto parete 4 vie
4 ways wall bracket
Support de face 4 voies
4läufiger Wandträger
Soporte a pared 4 vías
Wspornik do ściany 4 biegi

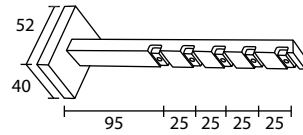

353259

Supporto parete 5 vie
5 ways wall bracket
Support de face 5 voies
5läufiger Wandträger
Soporte a pared 5 vías
Wspornik do ściany 5 biegi

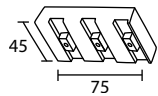

353539

Supporto a soffitto 3 vie
3 ways ceiling bracket
Support à plafond 3 voies
3läufiger Deckenträger
Soporte a techo 3 vías
Wspornik do sufitu 3 biegi

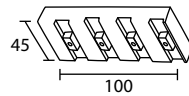

353549

Supporto a soffitto 4 vie
4 ways ceiling bracket
Support à plafond 4 voies
4läufiger Deckenträger
Soporte a techo 4 vías
Wspornik do sufitu 4 biegi

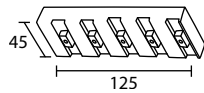

353559

Supporto a soffitto 5 vie
5 ways ceiling bracket
Support à plafond 5 voies

5läufiger Deckenträger
Soporte a techo 5 vías
Wspornik do sufitu 5 biegi

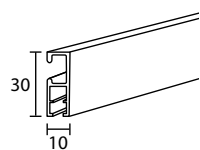

353200

Profilo portante
Main profile
Profil principal
Tragprofil
Perfil principal
Profil nosny

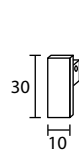

353245

Tappo profilo portante
Endcap main profile
Bouchon profil principal
Endkappe Für Tragprofil
Tapón perfil principal
Zatyczka do profilu nosnego

Vie = Vie - Ways - Voies - Schiene - Vías - Biegi

Cod.		353229	353239
FIN	L - mm	120	145
25 - 312	Vie	2	3
67			

Cod.		353249	353259
FIN	L - mm	170	195
25 - 312	Vie	4	5
67			

Cod.		353539	353549
FIN	Vie	3	4
25 - 312			
67			

Cod.		353559
FIN	Vie	5
25 - 312		
67		

Cod.		353200	353245
FIN	L - mt	1	
25 - 312			
67			

ERMINIA

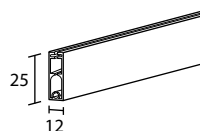

253120

Peso
Weight
Barre de lestage
Beschwerungsprofil
Perfil contrapeso
Obciążnik



253135

Tappo per peso
Endcap for weight
Bouchon pour barre de lestage
Endkappe Für Beschwerungsprofil
Tapón para contrapeso
Zaślepka obciążnika

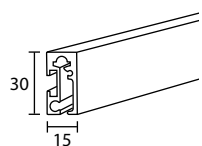

153300

Portatelo
Sliding Profile
Porte-panneau
Stoffhalter
Porta panel
Walek

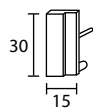

353245A

Tappo portatelo
Endcap for sliding profile
Bouchon porte-panneau
Stoffhaltende Endkappe
Tapón porta panel
Zatyczka do profilu nosnego

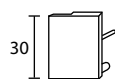

353245B

Tappo portatelo
Endcap for sliding profile
Bouchon porte-panneau

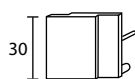

353245C

Stoffhaltende Endkappe
Tapón porta panel
Zatyczka do profilu nosnego

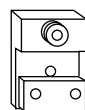

1111

Scorrevole portatelo
Wheel for sliding profile
Rondelle pour porte-panneau
Stoffhalter Gleiter
Corredera porta panel
Ślizgi wałka



513099

Maniglia
Handle
Poignée

Klinke
Manivela
Raczka

Vie = Vie - Ways - Voies - Schiene - Vías - Biegi

Cod.		253120	253135
FIN	L - mt	1	
25 - 312			
67			

Cod.		153300	353245A
FIN	L - mt	1	
25 - 312			
67			

Cod.		353245B	353245C
FIN			
25 - 312			
67			

Cod.		1111
FIN		
25 - 312		
67		

Cod.		513099
FIN		
25 - 312		
67		