

Cod. 623P19...SX / DX

Sistema a parete
Wall system

Cod. 623R19...SX / DX (with fixing bar)

Système de face
Wandmontage

Sistema pared
System ścienny

Cod.	623719SX / DX	623729SX / DX
A - mm	100	140
H - mm	50	95

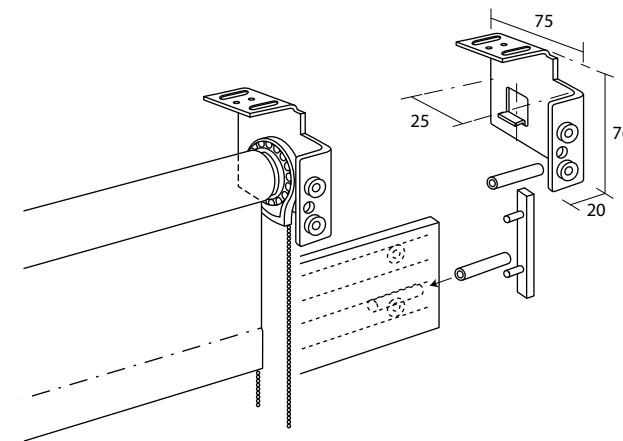
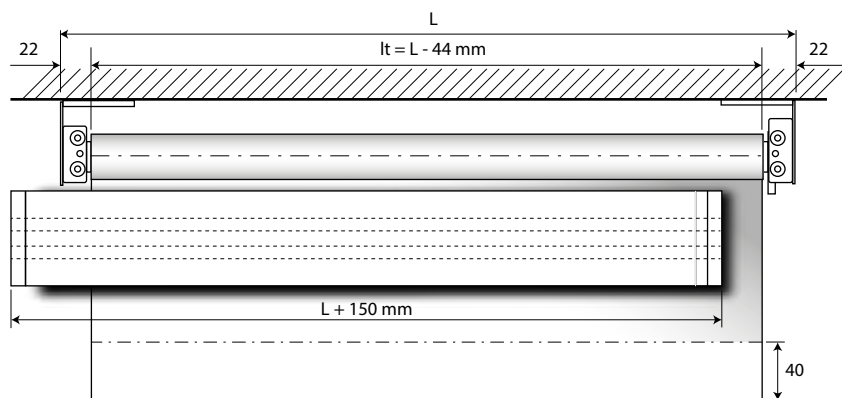

Cod. 623S19...SX / DX

Sistema a soffitto
Ceiling system

Cod. 623Z19...SX / DX (with fixing bar)

Système plafond
Deckenmontage

Sistema techo
System sufitowy



86



87

A = Sporgenza supporto - Bracket's projection - Retour support - Träger Abstand - Escuadra de separación - Występowornika
H = Distanza parete - Wall distance - Retour du mur - Wand Abstand - Distancia pared - Odległość od ściany
H1 = Altezza supporto - Bracket height - Hauteur support - Halterungshöhe - Altura soporte - Wysokość wspornika
L = Larghezza sistema (cm) - System width (cm) - Largeur système (cm) - Gesamtbreite (cm) - Ancho sistema (cm) - Szerokość systemu (cm)
lt = Larghezza singolo tessuto - Fabric width per unit - Largeur chaque toile - Stoff Breite - Ancho de cada tejido - Szerokość pojedynczej tkaniny

FIN 86 - 87

Supporti - Brackets - Supports - Träger - Soportes - Wsporniki Cod.623719

L - cm CT	80						100						120						140					
	A	B	C	D	E	F	A	B	C	D	E	F	A	B	C	D	E	F	A	B	C	D	E	F
120	C - cm																							
140																								
160																								
180																								
200																								
220																								
240																								
260																								
280																								
300																								

L - cm CT	160						180						200						220					
	A	B	C	D	E	F	A	B	C	D	E	F	A	B	C	D	E	F	A	B	C	D	E	F
120	C - cm																							
140																								
160																								
180																								
200																								
220																								
240																								
260																								
280																								
300																								

L - cm CT	240						260						280						300					
	A	B	C	D	E	F	A	B	C	D	E	F	A	B	C	D	E	F	A	B	C	D	E	F
120	C - cm																							
140																								
160																								
180																								
200																								
220																								
240																								
260																								
280																								
300																								

Rullo Ø 40 fino a 180 cm - Rullo Ø 46 oltre 180 cm più molla - Catena in plastica trasparente (Maggiorazione per catena in metallo Euro 20,00) - Peso interno 40x4 mm
 Tube Ø 40 up to 180 cm - Tube Ø 46 over 180 cm plus spring - Transparent plastic chain (Upcharge for metal chain Euro 20,00) - Internal bottom weight bar 40x4 mm
 Tube Ø 40 jusqu'à 180 cm - Tube Ø 46 au-dessus de 180 cm plus ressort - Chainette plastique transparente (Supplément pour chainette métal Euro 20,00) - Barre de lestage interne 40x4 mm
 Rolle Ø 40 bis 180 cm - Rolle 40 bis 180 cm inkl. Feder - Durchsichtige Kunststoffkette (Zuschlag für Metallkette 20,00 Euro) - Internes Gewicht 40x4 mm
 Tubo Ø 40 hasta 180 cm - Tubo Ø 46 arriba 180 cm más muelle - Cadena plástico transparente (Suplemento para cadena metal Euro 20,00) - Perfil contrapeso interior 40x4 mm
 Walek Ø 40 do 180 cm - Walek Ø 46 l powyżej 180 cm plus sprężyna - łańcuszek przezroczysty plastikowy (dopłata za łańcuszek metalowy 20,00 Eur) - Obciążnik wewnętrzny 40x4 mm

Maggiorazioni - Surcharges - Suppléments - Zuschläge - Suplementos - Dodatkowa opłata

Barra portarullo - Fixing bar - Barre de fixation - Rollenhalterungsstange - Barra de fijación - Walek rolety

L - cm	80	100	120	140	160	180	200	220	240	260	280	300
86 - 87												

FIN = Finitura - Finish - Finition - Fertigung - Acabado - Wykończenie
 L = Larghezza sistema (cm) - System width (cm) - Largeur système (cm) - Gesamtbreite (cm) - Ancho sistema (cm) - Szerokość systemu (cm)
 CT = Classe tessuto - Fabric category - Catégorie tissu - Gewebegruppe - Categoría tejido - Klasa tkaniny
 C = Altezza tessuto (cm) - Fabric height (cm) - Hauteur de la toile (cm) - Stoff Höhe (cm) - Altura tejido (cm) - Wysokość tkaniny (cm)

ARIES

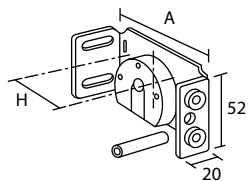

6237--

Lato Perno
Pivot Side
Côté Pivot

Träger Achseseite
Lado pivote
Strona czopa

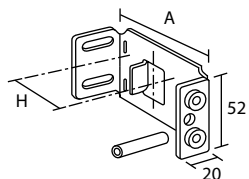

6237--

Lato catena
Chain side
Côté chainette

Träger Ketteseite
Lado cadena
Strona łańcuszka

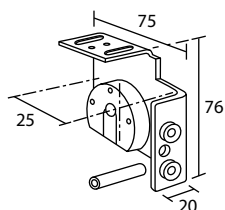

623738

Lato Perno
Pivot Side
Côté Pivot

Träger Achseseite
Lado pivote
Strona czopa

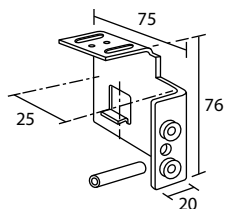

623739

Lato catena
Chain side
Côté chainette

Träger Ketteseite
Lado cadena
Strona łańcuszka

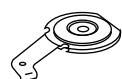

373999

Chiavetta zincata
Bracket
Support

Verzinkter Keil
Soporte
Kluczyk ocynkowany

SISTEMA A PARETE - WALL SYSTEM - SYSTÈME DE FACE - WANDMONTAGE - SISTEMA PARED - SYSTEM ŚCIENNY

Cod.		623718SX / DX	623728SX / DX
FIN	A - mm	100	140
	H - mm	50	95
86 - 87			

Cod.		623719SX / DX	623729SX / DX
FIN	A - mm	100	140
	H - mm	50	95
86 - 87			

SISTEMA A SOFFITTO - CEILING SYSTEM - SYSTÈME PLAFOND - DECKENMONTAGE - SISTEMATECHO - SYSTEM SUFITOWY

Cod.		623738
FIN		
86 - 87		

Cod.		623739
FIN		
86 - 87		

COMPONENTI - COMPONENTS - COMPOSANTS - ZUBEHÖR - COMPONENTES - CZĘŚCI

Cod.		373999
FIN		

ARIES

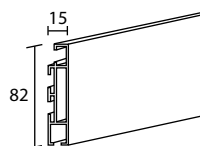

853300
 Profilo frontale
 Frontal profile
 Profil frontal
 Blende
 Perfil frontal
 Profil przedni



853311
 Tappo
 End cap
 Bouchon
 Endkappe
 Tapón
 Zatyčka

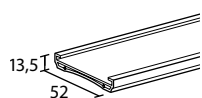

663999
 Barra portarullo
 Fixing bar
 Barre de fixation
 Rollenhalterungsstange
 Barra de fijación
 Wałek do rolety



1032
 Catena metallo cromata
 Chromed metal chain
 Chainette metal chromé
 Verchromte Metallkette
 Cadena metálica cromada
 Łańcuszek metalowy chromowany

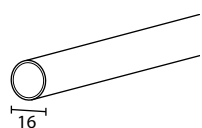

164100
 Peso
 Weight bar
 Barre de lestage
 Beschwerungsprofil
 Perfil contrapeso
 Obciążnik

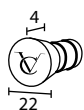

163055
 Tappo per peso
 Endcap for weight bar
 Bouchon pour barre de lestage
 Endkappe Für Beschwerungsprofil
 Tapón para contrapeso
 Zaślepka obciążnika

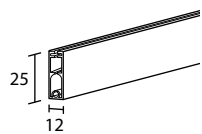

253120
 Peso
 Weight bar
 Barre de lestage
 Beschwerungsprofil
 Perfil contrapeso
 Obciążnik



253135
 Tappo per peso
 Endcap for weight bar
 Bouchon pour barre de lestage
 Endkappe Für Beschwerungsprofil
 Tapón para contrapeso
 Zaślepka obciążnika

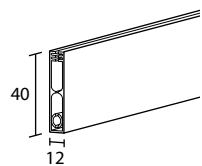

403120
 Peso
 Weight bar
 Barre de lestage
 Beschwerungsprofil
 Perfil contrapeso
 Obciążnik

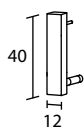

403125
 Tappo per peso
 Endcap for weight bar
 Bouchon pour barre de lestage
 Endkappe Für Beschwerungsprofil
 Tapón para contrapeso
 Zaślepka obciążnika

COMPONENTI - COMPONENTS - COMPOSANTS - ZUBEHÖR - COMPONENTES - CZĘŚCI

Cod.		853300	853311
FIN	L - mt	1	
86 - 87			

Cod.		663999	1032
FIN	L - mt	1	5
03			
86 - 87			

Cod.		164100	163055
FIN	L - mt	1	
312			
67			

Cod.		253120	253135
FIN	L - mt	1	
86 - 87			

Cod.		403120	403125
FIN	L - mt	1	
312			
67			