

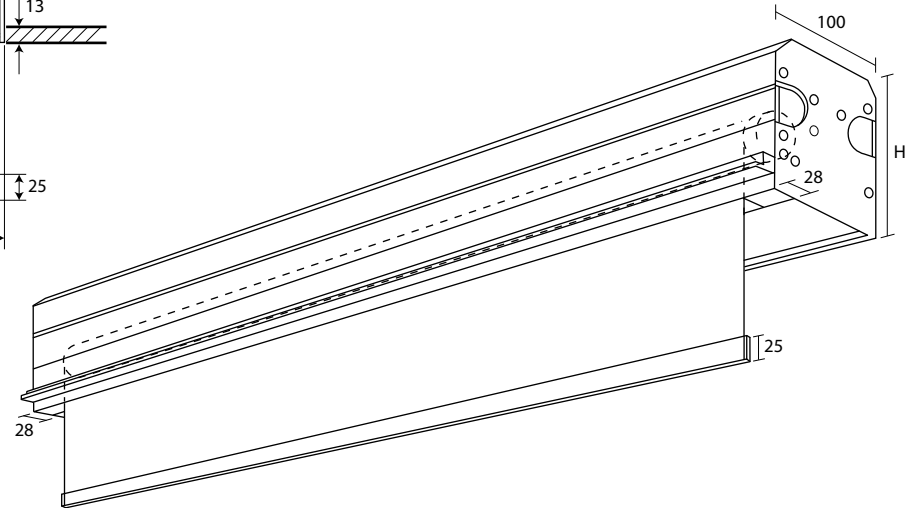

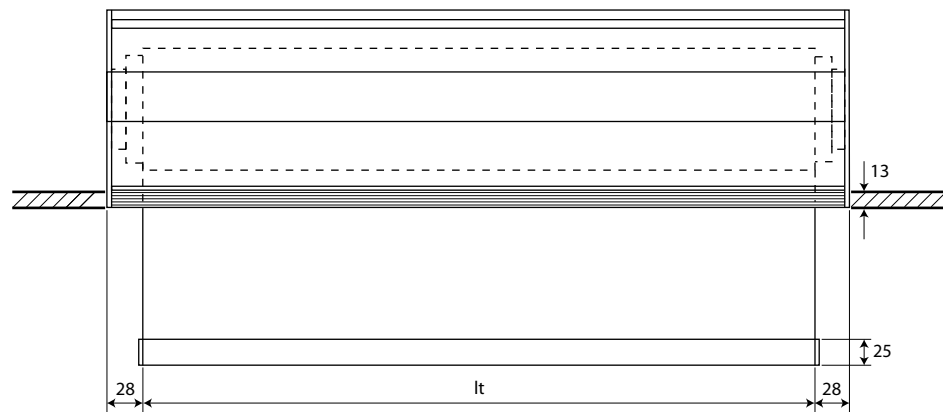

PAN - PAN MINI

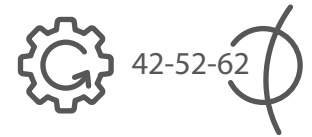

PAN
Cod. 793T29...SX / DX*
Sistema soffitto ad incasso
Ceiling built-in system
Système encaissé plafond

PAN MINI
Cod. 793T39...SX / DX*
Deckeneinbausystem
Sistema a techo empotrado
System sufitowy do wbudowania

| Cod. | PAN 793T29...SX / DX | PAN MINI 793T39...SX / DX |
|--------|----------------------|---------------------------|
| H - mm | 120 | 100 |



312

lt = Larghezza singolo tessuto - Fabric width per unit - Largeur chaque toile - Stoff Breite - Ancho de cada tejido - Szerokość pojedynczej tkaniny

FIN 312

| L - cm CT | 120 | | | | | | 140 | | | | | | 160 | | | | | | 180 | | | | | |
|--------------|--------|---|---|---|---|---|-----|---|---|---|---|---|-----|---|---|---|---|---|-----|---|---|---|---|---|
| | A | B | C | D | E | F | A | B | C | D | E | F | A | B | C | D | E | F | A | B | C | D | E | F |
| 120 | C - cm | | | | | | | | | | | | | | | | | | | | | | | |
| 140 | | | | | | | | | | | | | | | | | | | | | | | | |
| 160 | | | | | | | | | | | | | | | | | | | | | | | | |
| 180 | | | | | | | | | | | | | | | | | | | | | | | | |
| 200 | | | | | | | | | | | | | | | | | | | | | | | | |
| 220 | | | | | | | | | | | | | | | | | | | | | | | | |
| 240 | | | | | | | | | | | | | | | | | | | | | | | | |
| 260 | | | | | | | | | | | | | | | | | | | | | | | | |
| 280 | | | | | | | | | | | | | | | | | | | | | | | | |
| 300 | | | | | | | | | | | | | | | | | | | | | | | | |

| L - cm CT | 200 | | | | | | 220 | | | | | | 240 | | | | | | 260 | | | | | |
|--------------|--------|---|---|---|---|---|-----|---|---|---|---|---|-----|---|---|---|---|---|-----|---|---|---|---|---|
| | A | B | C | D | E | F | A | B | C | D | E | F | A | B | C | D | E | F | A | B | C | D | E | F |
| 120 | C - cm | | | | | | | | | | | | | | | | | | | | | | | |
| 140 | | | | | | | | | | | | | | | | | | | | | | | | |
| 160 | | | | | | | | | | | | | | | | | | | | | | | | |
| 180 | | | | | | | | | | | | | | | | | | | | | | | | |
| 200 | | | | | | | | | | | | | | | | | | | | | | | | |
| 220 | | | | | | | | | | | | | | | | | | | | | | | | |
| 240 | | | | | | | | | | | | | | | | | | | | | | | | |
| 260 | | | | | | | | | | | | | | | | | | | | | | | | |
| 280 | | | | | | | | | | | | | | | | | | | | | | | | |
| 300 | | | | | | | | | | | | | | | | | | | | | | | | |

| L - cm CT | 280 | | | | | | 300 | | | | | | | | | | | | | | | | |
|--------------|--------|---|---|---|---|---|-----|---|---|---|---|---|---|---|---|---|---|---|---|---|---|---|---|
| | A | B | C | D | E | F | A | B | C | D | E | F | A | B | C | D | E | F | A | B | C | D | E |
| 120 | C - cm | | | | | | | | | | | | | | | | | | | | | | |
| 140 | | | | | | | | | | | | | | | | | | | | | | | |
| 160 | | | | | | | | | | | | | | | | | | | | | | | |
| 180 | | | | | | | | | | | | | | | | | | | | | | | |
| 200 | | | | | | | | | | | | | | | | | | | | | | | |
| 220 | | | | | | | | | | | | | | | | | | | | | | | |
| 240 | | | | | | | | | | | | | | | | | | | | | | | |
| 260 | | | | | | | | | | | | | | | | | | | | | | | |
| 280 | | | | | | | | | | | | | | | | | | | | | | | |
| 300 | | | | | | | | | | | | | | | | | | | | | | | |

* Sistema solo motorizzato. Prezzo motore escluso (pag 1-M) - Motorized system only. Price of the motor not included (see page 1-M)
 Système uniquement motorisé. Prix moteur non inclus (voir page 1-M) - System nur motorisiert. Preis für Motor nicht enthalten (Seite 1-M)
 Sistema sólo motorizado. Precio motor no incluido (ver página 1-M) - Tylko system zmotoryzowany. Cena silnika nie jest wliczona (pag 1-M)

FIN = Finitura - Finish - Finition - Fertigung - Acabado - Wykończenie
 L = Larghezza sistema (cm) - System width (cm) - Largeur système (cm) - Gesamtbreite (cm) - Ancho sistema (cm) - Szerokość systemu (cm)
 CT = Classe tessuto - Fabric category - Catégorie tissu - Gewebegruppe - Categoría tejido - Klasa tkaniny
 C = Altezza tessuto (cm) - Fabric height (cm) - Hauteur de la toile (cm) - Stoff Höhe (cm) - Altura tejido (cm) - Wysokość tkaniny (cm)

PAN - PAN MINI

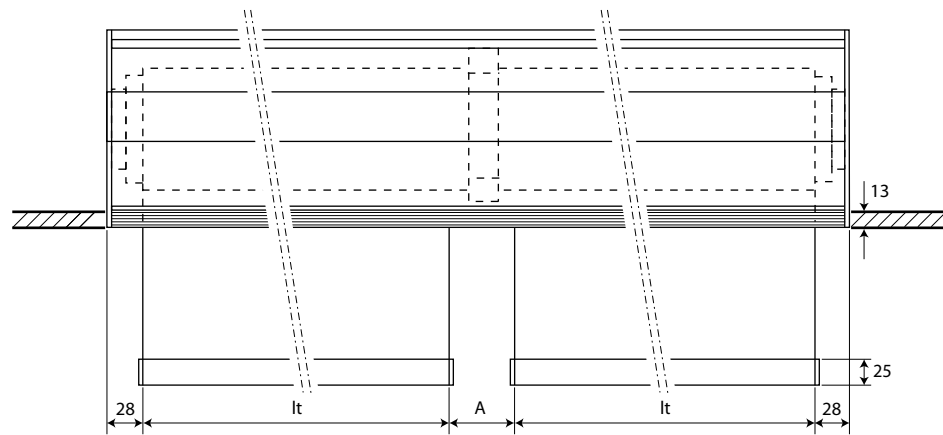
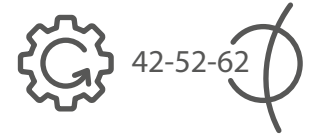

PAN
Cod. 793W59...SX / DX*
Sistema continuo a soffitto ad incasso
Ceiling consecutive built-in system
Système continu encaissé plafond

PAN MINI
Cod. 793W69...SX / DX*
Deckeneinbausystem mit Seite an Seite
Sistema continuo a techo empotrado
System sufitowy ciągły do wbudowania

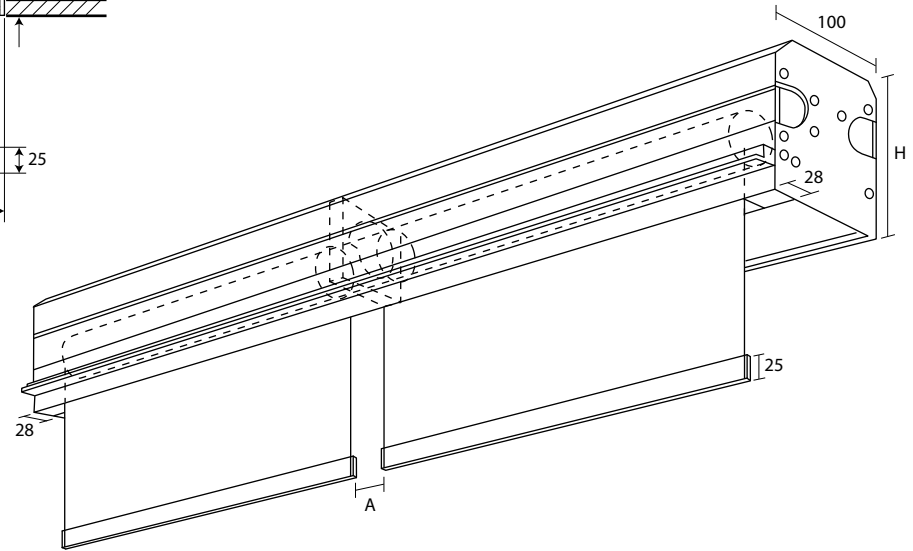

| Cod. | PAN 793W59...SX / DX | PAN MINI 793W69...SX / DX |
|--------|--------------------------------------------------------------|-------------------------------------------------------------------|
| H - mm | 120 | 100 |
| A - mm | 1 motore - 1 motor - 1 moteur - 1 Motor - 1 motor - 1 silnik | 2 motori - 2 motors - 2 moteurs - 2 Motoren - 2 motores - silniki |
| | 18 | 56 |



312

FIN 312

| L - cm CT | 320 | | | | | | 360 | | | | | | 400 | | | | | | 440 | | | | | |
|--------------|--------|---|---|---|---|---|-----|---|---|---|---|---|-----|---|---|---|---|---|-----|---|---|---|---|---|
| | A | B | C | D | E | F | A | B | C | D | E | F | A | B | C | D | E | F | A | B | C | D | E | F |
| 120 | C - cm | | | | | | | | | | | | | | | | | | | | | | | |
| 140 | | | | | | | | | | | | | | | | | | | | | | | | |
| 160 | | | | | | | | | | | | | | | | | | | | | | | | |
| 180 | | | | | | | | | | | | | | | | | | | | | | | | |
| 200 | | | | | | | | | | | | | | | | | | | | | | | | |
| 220 | | | | | | | | | | | | | | | | | | | | | | | | |
| 240 | | | | | | | | | | | | | | | | | | | | | | | | |
| 260 | | | | | | | | | | | | | | | | | | | | | | | | |
| 280 | | | | | | | | | | | | | | | | | | | | | | | | |
| 300 | | | | | | | | | | | | | | | | | | | | | | | | |

| L - cm CT | 480 | | | | | | 520 | | | | | | 560 | | | | | | 600 | | | | | |
|--------------|--------|---|---|---|---|---|-----|---|---|---|---|---|-----|---|---|---|---|---|-----|---|---|---|---|---|
| | A | B | C | D | E | F | A | B | C | D | E | F | A | B | C | D | E | F | A | B | C | D | E | F |
| 120 | C - cm | | | | | | | | | | | | | | | | | | | | | | | |
| 140 | | | | | | | | | | | | | | | | | | | | | | | | |
| 160 | | | | | | | | | | | | | | | | | | | | | | | | |
| 180 | | | | | | | | | | | | | | | | | | | | | | | | |
| 200 | | | | | | | | | | | | | | | | | | | | | | | | |
| 220 | | | | | | | | | | | | | | | | | | | | | | | | |
| 240 | | | | | | | | | | | | | | | | | | | | | | | | |
| 260 | | | | | | | | | | | | | | | | | | | | | | | | |
| 280 | | | | | | | | | | | | | | | | | | | | | | | | |
| 300 | | | | | | | | | | | | | | | | | | | | | | | | |

*Sistema solo motorizzato. Prezzo motore escluso (pag 1-M) - Motorized system only. Price of the motor not included (see page 1-M)
 Système uniquement motorisé. Prix moteur non inclus (voir page 1-M) - System nur motorisiert. Preis für Motor nicht enthalten (Seite 1-M)
 Sistema sólo motorizado. Precio motor no incluido (ver página 1-M) - Tylko system zmotoryzowany. Cena silnika nie jest wliczona (pag 1-M)



PAN - PAN MINI

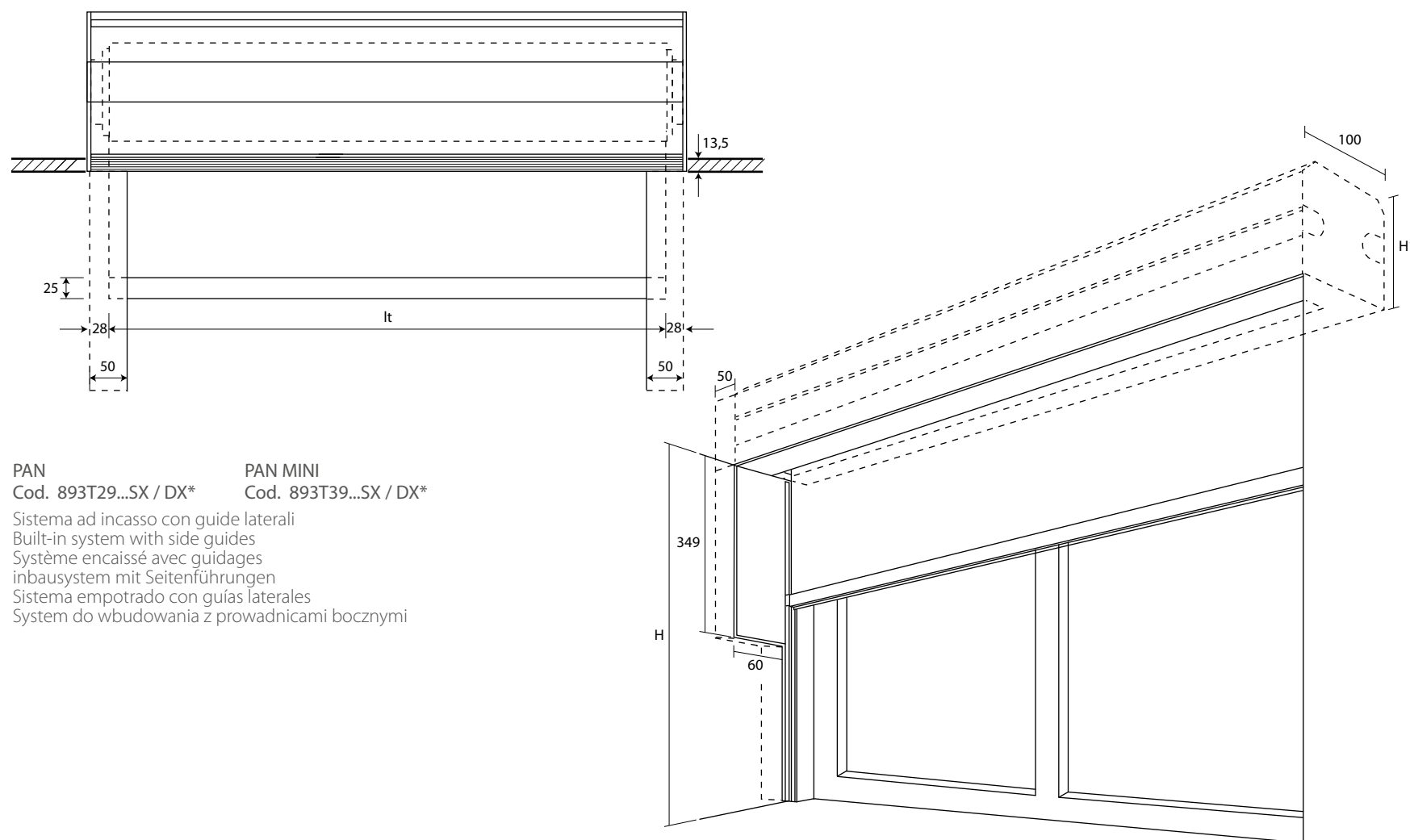

PAN Cod. 893T29...SX / DX* PAN MINI Cod. 893T39...SX / DX*
 Sistema ad incasso con guide laterali Built-in system with side guides
 Système encaissé avec guidages inbausystem mit Seitenführungen
 Sistema empotrado con guías laterales System do wbudowania z prowadnicami bocznymi

| Cod. | PAN 893T29...SX / DX | PAN MINI 893T39...SX / DX |
|---------|----------------------|---------------------------|
| H1 - mm | 120 | 100 |

Maggiorazioni - Surcharges - Suppléments - Zuschläge - Suplementos - Dodatkowa opłata

Coppia guide laterali - Pair of side guides - Paire de guides latérales - Paar seitliche Führungen - Par de guías laterales - Para prowadnic bocznych

| H - cm | 80 | 100 | 120 | 140 | 160 | 180 | 200 | 220 | 240 | 260 | 280 | 300 |
|--------|----|-----|-----|-----|-----|-----|-----|-----|-----|-----|-----|-----|
| | | | | | | | | | | | | |

I seguenti prezzi vanno aggiunti al prezzo del sistema Pan a soffitto ad incasso - The following prices must be added to the price of the Pan ceiling built-in system

Les prix suivants sont à rajouter au prix du système Pan plafond encastré - Die folgenden Preise addieren sich zum Preis von Pan (Deckeneinbau)

Los precios siguientes tienen que ser añadidos al precio del Sistema Pan a techo empotrado - Do ceny systemu Pan wpuszczanego do sufitu podwieszanego należy dodać następujące ceny



PAN

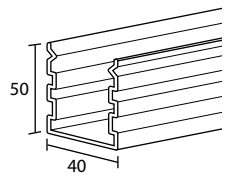

533999

Guida femmina
Female guide
Guidage femelle

Führungsschlitz
Guía hembra
Przewodnik żeński

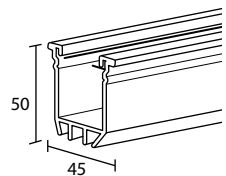

543999

Guida maschio
Male guide
Guidage mâle

Führungszapfen
Guía mach
Przewodnik męski



643999

Coperchio
Cover
Couverture

Abdeckung
Tapa
Okładka

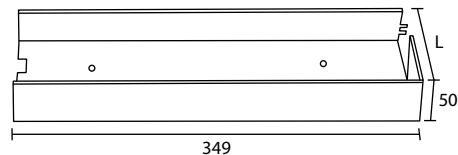

153999

Scatola
Box
Boîte

Schachtel
Caja
Box

COMPONENTI - COMPONENTS - COMPOSANTS - ZUBEHÖR - COMPONENTES - CZĘŚCI

| Cod. | | 533999 |
|------|--------|--------|
| FIN | L - mt | 1 |

| Cod. | | 543999 |
|------|--------|--------|
| FIN | L - mt | 1 |

| Cod. | | 643999 | 653999 |
|------|--------|--------|--------|
| FIN | L - mm | 60 | 95 |

| Cod. | | 153999 | 163999 |
|------|--------|--------|--------|
| FIN | L - mm | 100 | 130 |

PAN

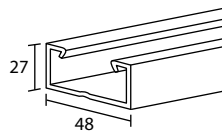

553999

Profilo montante
Upright profile
Profil montant

Profil Stütze
Perfile montante
Profil montażowy

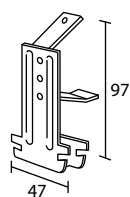

1056

Gancio con molla
Hook with spring
Crochet avec ressort

Haken mit Feder
Gancho con muelle
Hak ze sprężyną

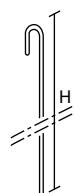

1057 1058 1059

Pendino
Hook
Croche

Haken
Gancho
Hak

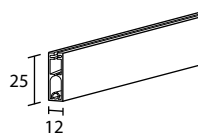

253120

Peso
Weight bar
Barre de lestage
Beschwerungsprofil
Perfil contrapeso
Obciążnik



253135

Tappo per peso
Endcap for weight bar
Bouchon pour barre de lestage
Endkappe Für Beschwerungsprofil
Tapón para contrapeso
Zaslepka obciążnika

COMPONENTI - COMPONENTS - COMPOSANTS - ZUBEHÖR - COMPONENTES - CZĘŚCI

| | | |
|-------------|---------------|----------|
| Cod. | 553999 | |
| FIN | L - mt | 1 |
| 312 | | |

| | | |
|-------------|-------------|--|
| Cod. | 1056 | |
| FIN | | |

| | | | |
|-------------|---------------|-------------|-------------|
| Cod. | 1057 | 1058 | 1059 |
| FIN | H - mm | 20 | 50 |
| | | | 100 |

| | | |
|-------------|---------------|---------------|
| Cod. | 253120 | 253135 |
| FIN | L - mt | 1 |
| 312 | | |